

### General Description



The products listed above are micro-PLC+HMIs, rugged programmable logic controllers that comprise built-in operating panels.

Detailed Installation Guides containing the I/O wiring diagrams for these models, technical specifications, and additional documentation are located in the Technical Library in the Unitronics website:



<https://unitronicsplc.com/support-technical-library/>

### Alert Symbols and General Restrictions



When any of the following symbols appear, read the associated information carefully.

Symbol	Meaning	Description
	Danger	The identified danger causes physical and property damage.
	Warning	The identified danger could cause physical and property damage.
<i>Caution</i>	Caution	Use caution.

- Before using this product, the user must read and understand this document.
- All examples and diagrams are intended to aid understanding, and do not guarantee operation. Unitronics accepts no responsibility for actual use of this product based on these examples.
- Please dispose of this product according to local and national standards and regulations.
- Only qualified service personnel should open this device or carry out repairs.

	▪ Failure to comply with appropriate safety guidelines can cause severe injury or property damage.
	▪ Do not attempt to use this device with parameters that exceed permissible levels. ▪ To avoid damaging the system, do not connect/disconnect the device when power is on.

### Environmental Considerations

	▪ Do not install in areas with: excessive or conductive dust, corrosive or flammable gas, moisture or rain, excessive heat, regular impact shocks or excessive vibration, in accordance with the standards given in the product's technical specification sheet. ▪ Do not place in water or let water leak onto the unit. ▪ Do not allow debris to fall inside the unit during installation.
	▪ Ventilation: 10mm space required between controller's top/bottom edges & enclosure walls. ▪ Install at maximum distance from high-voltage cables and power equipment.

## Mounting

Note that figures are for illustrative purposes only.

### Dimensions

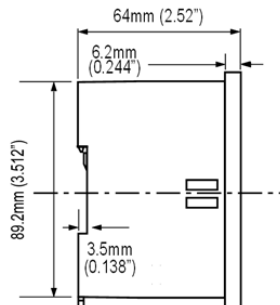
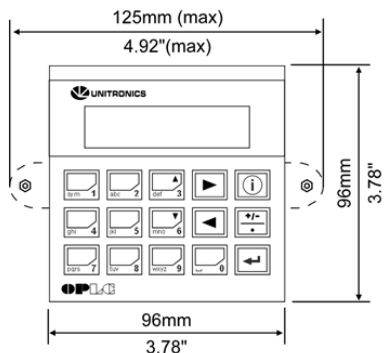

Model	Cut-out	View area
V120	92x92 mm (3.622"x3.622")	57.5x30.5mm (2.26"x1.2")
M91	92x92 mm (3.622"x3.622")	62x15.7mm (2.44"x0.61")

### Panel Mounting

Before you begin, note that the mounting panel cannot be more than 5 mm thick.

1. Make a panel cut-out of the appropriate size:
2. Slide the controller into the cut-out, ensuring that the rubber seal is in place.
3. Push the mounting brackets into their slots on the sides of the panel as shown in the figure below.
4. Tighten the bracket's screws against the panel. Hold the bracket securely against the unit while tightening the screw.
5. When properly mounted, the controller is squarely situated in the panel cut-out as shown in the accompanying figures.

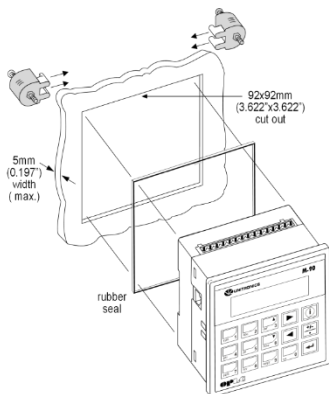

## DIN-rail Mounting

1. Snap the controller onto the DIN rail as shown in the figure to the right.

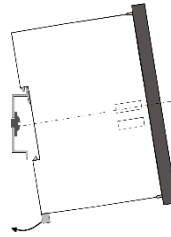

2. When properly mounted, the controller is squarely situated on the DIN-rail as shown in the figure to the right.

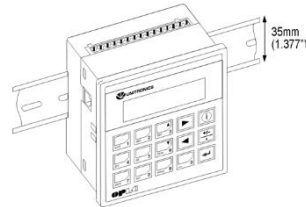

## Wiring



- Do not touch live wires.

- This equipment is designed to operate only in SELV/PELV/Class 2/Limited Power environments.
- All power supplies in the system must include double insulation. Power supply outputs must be rated as SELV/PELV/Class 2/Limited Power.
- Do not connect either the 'Neutral' or 'Line' signal of the 110/220VAC to device's 0V pin.
- All wiring activities should be performed while power is OFF.
- Use over-current protection, such as a fuse or circuit breaker, to avoid excessive currents into the power supply connection point.
- Unused points should not be connected (unless otherwise specified). Ignoring this directive may damage the device.
- Double-check all wiring before turning on the power supply.



- To avoid damaging the wire, do not exceed a maximum torque of:
  - Controllers offering a terminal block with pitch of 5mm: 0.5 N·m (5 kgf·cm).
  - Controllers offering a terminal block with pitch of 3.81mm f 0.2 N·m (2 kgf·cm).
- Do not use tin, solder, or any substance on stripped wire that might cause the wire strand to break.
- Install at maximum distance from high-voltage cables and power equipment.

*Caution*

## Wiring Procedure

Use crimp terminals for wiring;

- Controllers offering a terminal block with pitch of 5mm: 26-12 AWG wire (0.13 mm<sup>2</sup> –3.31 mm<sup>2</sup>).
- Controllers offering a terminal block with pitch of 3.81mm: 26-16 AWG wire (0.13 mm<sup>2</sup> – 1.31 mm<sup>2</sup>).

1. Strip the wire to a length of  $7\pm 0.5\text{mm}$  (0.270–0.300").
2. Unscrew the terminal to its widest position before inserting a wire.
3. Insert the wire completely into the terminal to ensure a proper connection.
4. Tighten enough to keep the wire from pulling free.

## Wiring Guidelines

- Use separate wiring ducts for each of the following groups:
    - Group 1: Low voltage I/O and supply lines, communication lines.
    - Group 2: High voltage Lines, Low voltage noisy lines like motor driver outputs.
 Separate these groups by at least 10cm (4"). If this is not possible, cross the ducts at a 90° angle.
  - For proper system operation, all 0V points in the system should be connected to the system 0V supply rail.
  - Product-specific documentation must be fully read and understood before performing any wiring.
- Allow for voltage drop and noise interference with input lines used over an extended distance.  
Use wire that is properly sized for the load.

## Earthing the product

To maximize system performance, avoid electromagnetic interference as follows:

- Use a metal cabinet.
- Connect the 0V and functional ground points (if exist) directly to the earth ground of the system.
- Use the shortest, less than 1m (3.3 ft.) and thickest,  $2.08\text{mm}^2$  (14AWG) min, wires possible.

## UL Compliance

The following section is relevant to Unitronics' products that are listed with the UL.

The following models: V120-22-T1, V120-22-T2C, V120-22-UA2, V120-22-UN2, M91-2-R1, M91-2-R2C, M91-2-R6, M91-2-R6C, M91-2-T1, M91-2-T2C, M91-2-UA2, M91-2-UN2 are UL listed for Hazardous Locations.

The following models: V120-22-R1, V120-22-R2C, V120-22-R34, V120-22-R6, V120-22-R6C, V120-22-RA22, V120-22-T1, V120-22-T2C, V120-22-T38, V120-22-UA2, V120-22-UN2, M91-2-FL1, M91-2-PZ1, M91-2-R1, M91-2-R2, M91-2-R2C, M91-2-R34, M91-2-R6, M91-2-R6C, M91-2-RA22, M91-2-T1, M91-2-T2C, M91-2-T38, M91-2-TC2, M91-2-UA2, M91-2-UN2, M91-2-ZK, M91-T4-FL1, M91-T4-PZ1, M91-T4-R1, M91-T4-R2, M91-T4-R2C, M91-T4-R34, M91-T4-R6, M91-T4-R6C, M91-T4-RA22, M91-T4-T1, M91-T4-T2C, M91-T4-T38, M91-T4-TC2, M91-T4-UA2, M91-T4-UN2, M91-T4-ZK are UL listed for Ordinary Location.

For models from series M91, that include "T4" in the Model name, Suitable for mounting on the flat surface of Type 4X enclosure.

For examples: M91-T4-R6

### UL Ordinary Location

In order to meet the UL ordinary location standard, panel-mount this device on the flat surface of Type 1 or 4 X enclosures

## **UL Ratings, Programmable Controllers for Use in Hazardous Locations,**

### **Class I, Division 2, Groups A, B, C and D**

These Release Notes relate to all Untronics products that bear the UL symbols used to mark products that have been approved for use in hazardous locations, Class I, Division 2, Groups A, B, C and D.

*Caution*   ▪ This equipment is suitable for use in Class I, Division 2, Groups A, B, C and D, or Non-hazardous locations only.



▪ Input and output wiring must be in accordance with Class I, Division 2 wiring methods and in accordance with the authority having jurisdiction.



▪ WARNING—Explosion Hazard—substitution of components may impair suitability for Class I, Division 2.

▪ WARNING – EXPLOSION HAZARD – Do not connect or disconnect equipment unless power has been switched off or the area is known to be non-hazardous.

▪ WARNING – Exposure to some chemicals may degrade the sealing properties of material used in Relays.

▪ This equipment must be installed using wiring methods as required for Class I, Division 2 as per the NEC and/or CEC.

---

### **Panel-Mounting**

For programmable controllers that can be mounted also on panel, in order to meet the UL Haz Loc standard, panel-mount this device on the flat surface of Type 1 or Type 4X enclosures.

---

### **Relay Output Resistance Ratings**

The products listed below contain relay outputs:

Programmable controllers, Models: M91-2-R1, M91-2-R2C, M91-2-R6C, M91-2-R6

- When these specific products are used in hazardous locations, they are rated at 3A res.
  - when these specific products are used in non-hazardous environmental conditions, they are rated at 5A res, as given in the product's specifications.
- 

### **Temperature Ranges**

Programmable Logic Controllers, Models, M91-2-R1, M91-2-R2C, M91-2-R6C.

- When these specific products are used in hazardous locations, they may be used only within a temperature range of 0-40°C (32- 104°F).
  - When these specific products are used in non-hazardous environmental conditions, they function within the range of 0-50°C (32- 122°F) given in the product's specifications.
- 

### **Removing / Replacing the battery**

When a product has been installed with a battery, do not remove or replace the battery unless the power has been switched off, or the area is known to be non-hazardous.

Please note that it is recommended to back up all data retained in RAM, in order to avoid losing data when changing the battery while the power is switched off. Date and time information will also need to be reset after the procedure.

### **UL des zones ordinaires:**

Pour respecter la norme UL des zones ordinaires, monter l'appareil sur une surface plane de type de protection 1 ou 4X

## **Certification UL des automates programmables, pour une utilisation en environnement à risques, Class I, Division 2, Groups A, B, C et D.**

Cette note fait référence à tous les produits Unitronics portant le symbole UL - produits qui ont été certifiés pour une utilisation dans des endroits dangereux, Classe I, Division 2, Groupes A, B, C et D.

*Attention* ■ Cet équipement est adapté pour une utilisation en Classe I, Division 2, Groupes A, B, C et D, ou dans Non-dangereux endroits seulement.



■ Le câblage des entrées/sorties doit être en accord avec les méthodes de câblage selon la Classe I, Division 2 et en accord avec l'autorité compétente.



■ AVERTISSEMENT: Risque d'Explosion – Le remplacement de certains composants rend caduque la certification du produit selon la Classe I, Division 2.

■ AVERTISSEMENT - DANGER D'EXPLOSION - Ne connecter pas ou ne débranche pas l'équipement sans avoir préalablement coupé l'alimentation électrique ou la zone est reconnue pour être non dangereuse.

■ AVERTISSEMENT - L'exposition à certains produits chimiques peut dégrader les propriétés des matériaux utilisés pour l'étanchéité dans les relais.

■ Cet équipement doit être installé utilisant des méthodes de câblage suivant la norme Class I, Division 2 NEC et /ou CEC.

### **Montage de l'écran:**

Pour les automates programmables qui peuvent aussi être monté sur l'écran, pour pouvoir être au standard UL, l'écran doit être monté dans un coffret avec une surface plane de type 1 ou de type 4X.

### **Certification de la résistance des sorties relais**

Les produits énumérés ci-dessous contiennent des sorties relais:

- Automates programmables, modèles : M91-2-R1, M91-2-R6C, M91-2-R6, M91-2-R2C
- Lorsque ces produits spécifiques sont utilisés dans des endroits dangereux, ils supportent un courant de 3A charge résistive.
- Lorsque ces produits spécifiques sont utilisés dans un environnement non dangereux, ils sont évalués à 5A res, comme indiqué dans les spécifications du produit Plages de températures.

### **Plages de température**

Les Automates programmables, modèles: M91-2-R1, M91-2-R2C, M91-2-R6C.

- Dans un environnement dangereux, ils peuvent être seulement utilisés dans une plage de température allant de 0 et 40° C (32- 104°F).
- Dans un environnement non dangereux, ils peuvent être utilisés dans une plage de température allant de 0 et 50° C (32- 122°F).

### **Retrait / Remplacement de la batterie**

Lorsqu'un produit a été installé avec une batterie, retirez et remplacez la batterie seulement si l'alimentation est éteinte ou si l'environnement n'est pas dangereux.

Veuillez noter qu'il est recommandé de sauvegarder toutes les données conservées dans la RAM, afin d'éviter de perdre des données lors du changement de la batterie lorsque l'alimentation est coupée. Les informations sur la date et l'heure devront également être réinitialisées après la procédure.

# V120-22-R34

## Graphic Operator Panel & Programmable Logic Controller

24 VDC, 22 pnp/npn digital inputs, including 2 analog inputs<sup>1</sup> and 3 high-speed counter/shaft encoder inputs, 12 relay outputs, I/O expansion port, 2 RS232/RS485 ports

<b>Power supply</b>	24VDC
Permissible range	20.4VDC to 28.8VDC with less than 10% ripple
Maximum current consumption	290mA@24VDC
<b>Digital inputs</b>	22 pnp (source) or npn (sink) inputs. See Notes 1 and 2
Nominal input voltage	24VDC. See Note 3.
Input voltages for pnp (source):	0-5VDC for Logic '0' 17-28.8VDC for Logic '1'
Input voltages for npn (sink):	17-28.8VDC/<1mA for Logic '0' 0-5VDC/>3mA for Logic '1'
Input current	3.7mA@24VDC
Input impedance	6.5kΩ
Response time (except high-speed inputs)	10mS typical
Galvanic isolation	None
Input cable length	Up to 100 meters, unshielded
<b>High-speed counter</b>	Specifications below apply when inputs are wired for use as a high-speed counter input/shaft encoder. See Notes 4 and 5.
Resolution	32-bit
Input freq.	10kHz max.
Minimum pulse	40µs

### pnp (source) high-speed counter

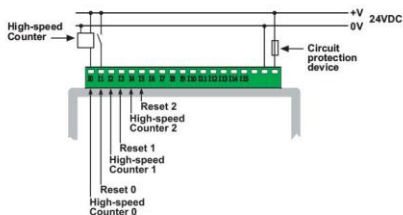

### npn (sink) high-speed counter

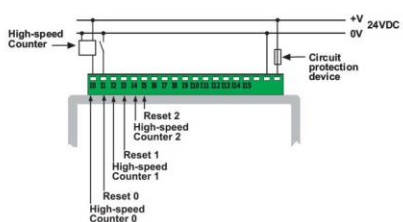

### Shaft encoder

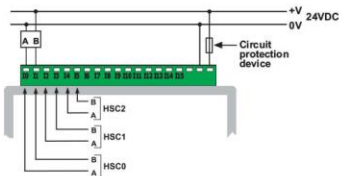

### Power supply, pnp (source) inputs

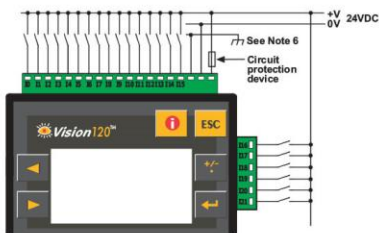

### npn (sink) inputs

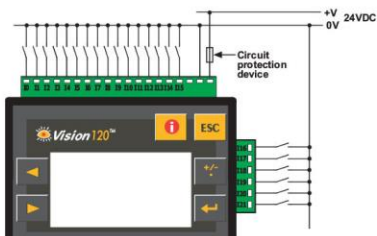

### Notes:

- The total number of inputs is 22. All of these may be used as normal digital inputs. Via jumper settings and wiring, certain of these inputs may be adapted to analog inputs.
- All 22 inputs can be set to pnp (source) or npn (sink) via a single jumper and appropriate wiring.
- npn (sink) inputs use voltage supplied from the controller's power supply.
- Inputs #0, #2 and #4 can each function as either high-speed counter or as part of a shaft encoder. In each case, high-speed input specifications apply. When used as a normal digital input, normal input specifications apply.
- Inputs #1, #3 and #5 can each function as either counter reset, or as a normal digital input; in either case, specifications are those of a normal digital input. These inputs may also be used as part of a shaft encoder. In this case, high-speed input specifications apply.
- To avoid electromagnetic interference, mount the controller in a metal panel/cabinet and earth the power supply. Earth the power supply signal to the metal using a wire whose length does not exceed 10cm. If your conditions do not permit this, do not earth the power supply.



### Warnings:

- Unused pins should not be connected. Ignoring this directive may damage the controller.
- Improper use of this product may severely damage the controller.
- Refer to the controller's User Guide regarding wiring considerations.
- Before using this product, it is the responsibility of the user to read the product's User Guide and all accompanying documentation.

<b>Analog Inputs</b>	Two 10-bit, multi-range inputs: 0-10V, 0-20mA, 4-20mA See Note 1 on page 1
Conversion method	Successive approximation
Input impedance	>150K $\Omega$ for voltage 243 $\Omega$ for current
Galvanic isolation	None
Resolution (except 4-20mA)	10-bit (1024 units)
Resolution at 4-20mA	204 to 1023 (820 units)
Conversion time	Synchronized to scan time
Absolute max. rating	$\pm 15V/30mA$
Full scale error	$\pm 2$ LSB
Linearity error	$\pm 2$ LSB
Status indication	Yes, See Note

**Note:**

The analog value can also indicate when the input is functioning out of range. If an analog input deviates above the permissible range, its value will be 1024.

**Voltage connection**

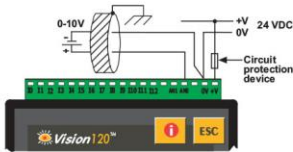

**Notes:**

- a. Shields should be connected at the signals' source.
- b. The 0V signal of the analog input must be connected to the controller's 0V.

**Current connections**

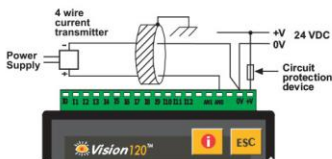
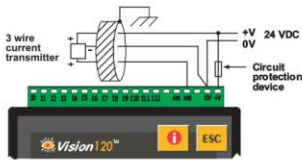
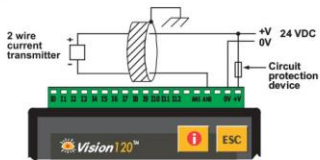

**Notes:**

- a. Shields should be connected at the signals' source.
- b. The 0V signal of the analog input must be connected to the controller's 0V.

<b>Relay outputs</b>	12 relay (in 3 groups) See Note
Output type	SPST-NO (Form A)
Type of relay	Tyco PCN-124D3MHZ or compatible
Isolation	by relay
Output current (resistive load)	3A max per output 8A max total for common
Rate voltage	250VAC / 30VDC
Minimum load	1mA@5VDC
Life expectancy	100k operations at maximum load
Response time	10ms (typical)
Contact protection	External precautions required (see below)

**Note:**

Outputs #0, #1, #2 and #3 share a common signal.  
Outputs #4, #5, #6 and #7 share a common signal.  
Outputs #8, #9, #10 and #11 share a common signal.

**Relay Outputs**

- Each Output can be wired separately to either AC or DC as shown below.
- The 0V signal of the relay outputs is isolated from the controller's 0V signal.

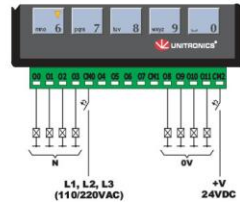

**Increasing Contact Life Span**

To increase the life span of the relay output contacts and protect the device from potential damage by reverse EMF, connect:

- a clamping diode in parallel to each inductive DC load.
- an RC snubber circuit in parallel with each inductive AC load.

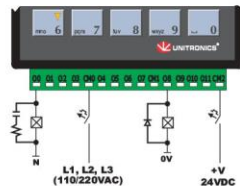



<b>Graphic Display</b>	STN, LCD display
Illumination backlight	LED, yellow-green, software-controlled
Display resolution	128x64 pixels

<b>Keypad</b>	Sealed membrane
Number of keys	16

<b>Program</b>	
Application memory	448K
Memory Bits (coils)	4096
Memory Integers (registers)	2048
Long Integers (32 bit)	256
Double Word (32 bit unsigned)	64
Floats	24
Timers	192
Counters	24
Data Tables	120K (RAM) / 64K (FLASH)
HMI displays	Up to 255
Execution time	0.8µs for bit operations

<b>RS232/RS485 serial ports</b>	Used for: <ul style="list-style-type: none"> <li>• Application Download/Upload</li> <li>• Application Testing (Debug)</li> <li>• Connect to GSM/GPRS or standard telephone modem: <ul style="list-style-type: none"> <li>- Send/receive SMS messages</li> <li>- Remote access programming</li> </ul> </li> <li>• RS485 Networking</li> </ul>
<b>RS232</b> (see note)	2 ports
Galvanic isolation	None
Voltage limits	±20V
<b>RS485</b> (see note)	2 ports
Input voltage	-7 to +12V differential max.
Cable type	Shielded twisted pair, in compliance with EIA RS485
Galvanic isolation	None
Baud rate	110 – 57600 bps
Nodes	Up to 32

**Note:**  
RS232/RS485 is determined by jumper settings and wiring.  
Refer to the controller's User Guide regarding communications.

<b>I/O expansion port</b>	Up to 128 additional I/Os, including digital and analog I/Os, temperature and weight inputs and more (number of I/Os may vary according to expansion model)
---------------------------	---

<b>Miscellaneous</b>	
Clock (RTC)	Real-time clock functions (Date and time).
Battery back-up	7 years typical at 25°C, battery back-up for RTC and system data.
Battery	Coin type, 3V lithium battery, CR2450
Weight	310g (10.9 oz.)
Operational temperature	0 to 50°C (32 to 122°F)
Storage temperature	-20 to 60°C (-4 to 140°F)
Relative Humidity (RH)	5% to 95% (non-condensing)
Mounting method	DIN-rail mounted (IP20/NEMA1) Panel mounted (IP65/NEMA4X)

# M91-2-R34

24 VDC, 22 pnp/npn digital inputs, including 2 analog inputs<sup>1</sup> and 3 high-speed counter/shaft encoder inputs, 12 relay outputs, I/O expansion port, RS232/RS485 port

<b>Power supply</b>	24VDC
Permissible range	20.4VDC to 28.8VDC with less than 10% ripple
Maximum current consumption	240mA@24VDC
<b>Digital inputs</b>	22 pnp (source) or npn (sink) inputs. See Notes 1 and 2.
Nominal input voltage	24VDC. See Note 3.
Input voltages for pnp (source):	0-5VDC for Logic '0' 17-28.8VDC for Logic '1'
Input voltages for npn (sink):	17-28.8VDC/<1mA for Logic '0' 0-5VDC/>3mA for Logic '1'
Input current	3.7mA@24VDC
Input impedance	6.5KΩ
Response time (except high-speed inputs)	10ms typical
Galvanic isolation	None
Input cable length	Up to 100 meters, unshielded
<b>High-speed counter</b>	Specifications below apply when inputs are wired for use as a high-speed counter input/shaft encoder. See Notes 4 and 5.
Resolution	16-bit
Input freq.	10kHz max.
Minimum pulse	40µs

## pnp (source) high-speed counter

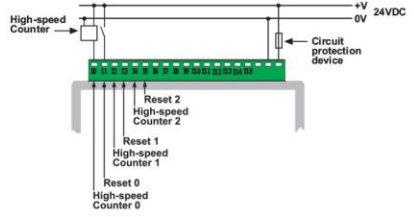

## npn (sink) high-speed counter

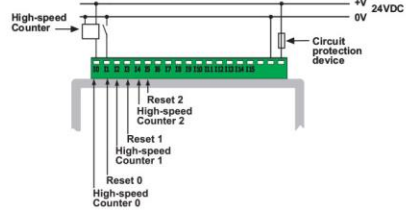

## Shaft encoder

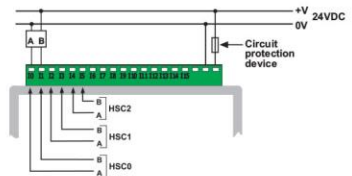

## Power supply, pnp (source) inputs

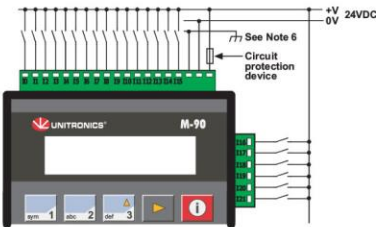

## npn (sink) inputs

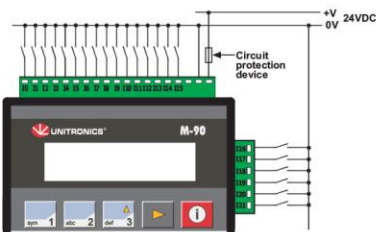

## Notes:

- The total number of inputs is 22. All of these may be used as normal digital inputs. Via jumper settings and wiring, certain of these inputs may be adapted to analog inputs.
- All 22 inputs can be set to pnp (source) or npn (sink) via a single jumper and appropriate wiring.
- nnp (sink) inputs use voltage supplied from the controller's power supply.
- Inputs #0, #2 and #4 can each function as either high-speed counter or as part of a shaft encoder. In each case, high-speed input specifications apply. When used as a normal digital input, normal input specifications apply.
- Inputs #1, #3 and #5 can each function as either counter reset, or as a normal digital input; in either case, specifications are those of a normal digital input. These inputs may also be used as part of a shaft encoder. In this case, high-speed input specifications apply.
- To avoid electromagnetic interference, mount the controller in a metal panel/cabinet and earth the power supply. Earth the power supply signal to the metal using a wire whose length does not exceed 10cm. If your conditions do not permit this, do not earth the power supply.

## Warnings

- Unused pins should not be connected. Ignoring this directive may damage the controller.
- Improper use of this product may severely damage the controller.
- Refer to the controller's User Guide regarding wiring considerations.
- Before using this product, it is the responsibility of the user to read the product's User Guide and all accompanying documentation.

<b>Analog Inputs</b>	Two 10-bit, multi-range inputs: 0-10V, 0-20mA, 4-20mA See Note 1 on page 1
Conversion method	Successive approximation
Input impedance	>150K $\Omega$ for voltage 243 $\Omega$ for current
Galvanic isolation	None
Resolution (except 4-20mA)	10-bit (1024 units)
Resolution at 4-20mA	204 to 1023 (820 units)
Conversion time	Synchronized to scan time
Absolute max. rating	$\pm 15V/30mA$
Full scale error	$\pm 2$ LSB
Linearity error	$\pm 2$ LSB
Status indication	Yes, See Note

**Note:**

The analog value can also indicate when the input is functioning out of range. If an analog input deviates above the permissible range, its value will be 1024.

**Voltage connection**

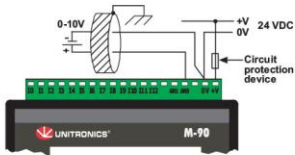

**Notes:**

- a. Shields should be connected at the signals' source.
- b. The 0V signal of the analog input must be connected to the controller's 0V.

**Current connections**

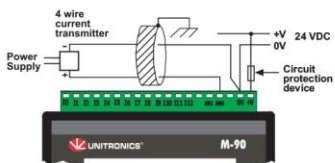
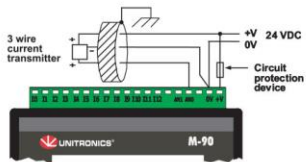
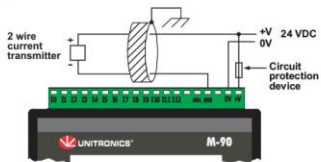

**Notes:**

- a. Shields should be connected at the signals' source.
- b. The 0V signal of the analog input must be connected to the controller's 0V.

<b>Relay outputs</b>	12 relay (in 3 groups) See Note
Output type	SPST-NO (Form A)
Type of relay	Tyco PCN-124D3MHZ or compatible
Isolation	by relay
Output current (resistive load)	3A max per output 8A max total for common
Rate voltage	250VAC / 30VDC
Minimum load	1mA@5VDC
Life expectancy	100k operations at maximum load
Response time	10mS (typical)
Contact protection	External precautions required (see below)

**Note:**

Outputs #0, #1, #2 and #3 share a common signal.  
Outputs #4, #5, #6 and #7 share a common signal.  
Outputs #8, #9, #10 and #11 share a common signal.

**Relay Outputs**

- Each Output can be wired separately to either AC or DC as shown below.
- The 0V signal of the relay outputs is isolated from the controller's 0V signal.

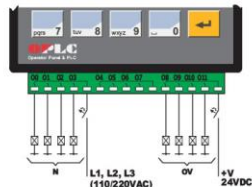

**Increasing Contact Life Span**

To increase the life span of the relay output contacts and protect the device from potential damage by reverse EMF, connect:

- a clamping diode in parallel to each inductive DC load.
- an RC snubber circuit in parallel with each inductive AC load.

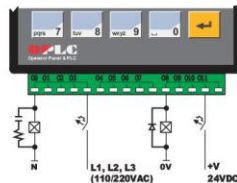

<b>Display</b>	STN, LCD display
Illumination	LED yellow-green backlight
Display size	2 lines, 16 characters long
Character size	5 x 8 matrix, 2.95 x 5.55mm

<b>Keypad</b>	Sealed membrane
Number of keys	15

<b>PLC program</b>	
Ladder Code Memory (virtual)	36K
Memory Bits (coils)	256
Memory Integers (Registers)	256
Timers	64
Execution time	12µsec. for bit operations
Database	1024 integers (indirect access)
HMI displays	80 user-designed displays
HMI variables	64 HMI variables are available to conditionally display and modify text, numbers, dates, times & timer values. The user can also create a list of up to 120 variable text displays, totaling up to 2K.

<b>RS232/RS485 serial port</b>	Used for: <ul style="list-style-type: none"> <li>● Application Download/Upload</li> <li>● Application Testing (Debug)</li> <li>● Connect to GSM or standard telephone modem: <ul style="list-style-type: none"> <li>- Send/receive SMS messages</li> <li>- Remote access programming</li> </ul> </li> <li>● RS485 Networking</li> </ul>
--------------------------------	---

<b>RS232</b> (see note)	1 port
Galvanic isolation	None
Voltage limits	±20V

<b>RS485</b> (see note)	1 port
Input voltage	-7 to +12V differential max.
Cable type	Shielded twisted pair, in compliance with EIA RS485
Galvanic isolation	None
Baud rate	110 – 57600 bps
Nodes	Up to 32

Note:  
RS232/RS485 is determined by jumper settings and wiring, as described in the document "M91 RS485 Port Settings" packaged with the controller.

<b>I/O expansion port</b>	Up to 64 additional I/Os, including digital & analog I/Os, RTD & more.
---------------------------	--

<b>Miscellaneous</b>	
Clock (RTC)	Real-time clock functions (Date and Time).
Battery back-up	7 years typical battery back-up for RTC and system data.
Weight	310g (10.9 oz.)
Operational temperature	0 to 50°C (32 to 122°F)
Storage temperature	-20 to 60°C (-4 to 140°F)
Relative Humidity (RH)	5% to 95% (non-condensing)
Mounting method	DIN-rail mounted (IP20/NEMA1) Panel mounted (IP65/NEMA4X)

# Jumper Settings

The tables below show how to set a specific jumper to change the functionality of the controller. To open the controller and access the jumpers, refer to the directions at the end of these specifications.

**Important:**

Incompatible jumper settings and wiring connections may severely damage the controller.

	Jumper #	NPN	PNP*
Digital Inputs	JP3	A	B

	Jumper #	Voltage	Current	Digital*
Analog 1 / I14	JP1	A	A	B
	JP4	A	B	B
Analog 0 / I15	JP2	A	A	B
	JP5	A	B	B

\*Default factory setting

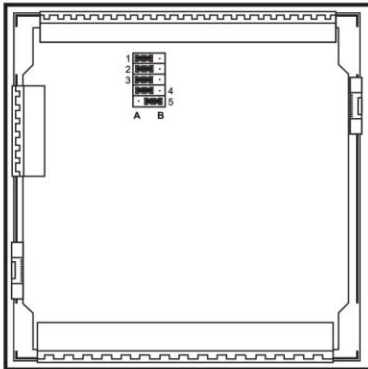

**In this figure, the jumper settings will cause the controller to function as follows:**

Digital inputs: npn, 24VDC inputs

Analog input 1: Voltage input

Analog input 0: Current input

## Communication Ports

Note that different controller models offer different serial and CANbus communication options. To see which options are relevant, check your controller's technical specifications.



- Turn off power before making communications connections.

### Caution

- Note that the serial ports are not isolated.
- Signals are related to the controller's 0V; the same 0V is used by the power supply.
- Always use the appropriate port adapters.

## Serial Communications

This series comprises 2 serial port can be set to either RS232 or RS485 according to jumper settings. By default, the ports are set to RS232.

Use RS232 to download programs from a PC, and to communicate with serial devices and applications, such as SCADA.

Use RS485 to create a multi-drop network containing up to 32 devices.

### Caution

- The serial ports are not isolated. If the controller is used with a non-isolated external device, avoid potential voltage that exceeds  $\pm 10V$ .

## Pinouts

The pinouts below show the signals between the adapter and port.

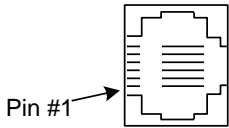
RS232		RS485		Controller Port 
Pin #	Description	Pin #	Description	
1*	DTR signal	1	A signal (+)	
2	0V reference	2	(RS232 signal)	
3	TXD signal	3	(RS232 signal)	
4	RXD signal	4	(RS232 signal)	
5	0V reference	5	(RS232 signal)	
6*	DSR signal*	6	B signal (-)	

\*Standard programming cables do not provide connection points for pins 1 and 6.

## RS232 to RS485: Changing Jumper Settings

- To access the jumpers, open the controller and then remove the module's PCB board. Before you begin, turn off the power supply, disconnect and dismount the controller.
- When a port is adapted to RS485, Pin 1 (DTR) is used for signal A, and Pin 6 (DSR) signal is used for signal B.
- If a port is set to RS485, **and** flow signals DTR and DSR are not used, the port can also be used to communicate via RS232; with the appropriate cables and wiring.



- Before performing these actions, touch a grounded object to discharge any electrostatic charge.
- Avoid touching the PCB board directly. Hold the PCB board by its connectors.

## Opening the controller

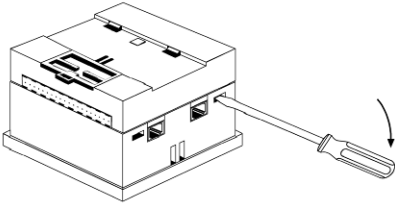

1. Turn power off before opening the controller.
2. Locate the 4 slots on the sides of the controller.
3. Using the blade of a flat-bladed screwdriver, gently pry off the back of the controller.

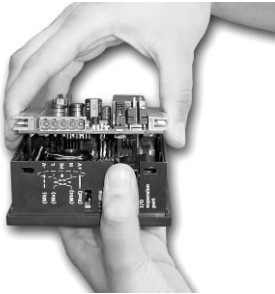

4. Gently remove the top PCB board:
  - a. Use one hand to hold the top-most PCB board by its top and bottom connectors.
  - b. With the other hand, grasp the controller, while keeping hold of the serial ports; this will keep the bottom board from being removed together with the top board.
  - c. Steadily pull the top board off.
5. Locate the jumpers, and then change the jumper settings as required.

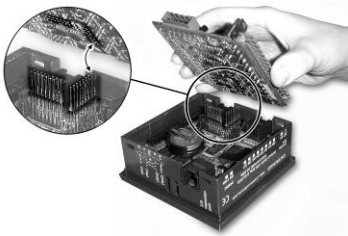

6. Gently replace the PCB board. Make certain that the pins fit correctly into their matching receptacle.
  - a. Do not force the board into place; doing so may damage the controller.
7. Close the controller by snapping the plastic cover back in its place. If the card is placed correctly, the cover will snap on easily.

**M91: RS232/RS485 Jumper Settings**

RS232/RS485 Jumper Setting		
To use as	Jumper 1	Jumper 2
RS232*	A	A
RS485	B	B

RS485 Termination		
Termination	Jumper 3	Jumper 4
ON*	A	A
OFF	B	B

\*Default factory setting.

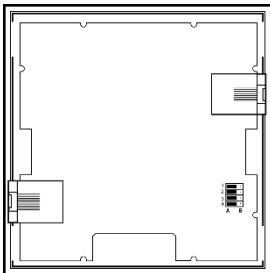

**V120: RS232/RS485 Jumper Settings**

	Jumper Settings		
	Jumper	RS232*	RS485
COM 1	1	A	B
	2	A	B
COM 2	5	A	B
	6	A	B

RS485 Termination		
Jumper	ON*	OFF
3	A	B
4	A	B
7	A	B
8	A	B

\*Default factory setting.

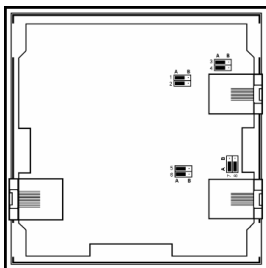



## CANbus

These controllers comprise a CANbus port. Use this to create a decentralized control network of up to 63 controllers, using either Unitronics' proprietary CANbus protocol or CANopen.

The CANbus port is galvanically isolated.

### CANbus Wiring

Use twisted-pair cable. DeviceNet® thick shielded twisted pair cable is recommended.

Network terminators: These are supplied with the controller. Place terminators at each end of the CANbus network.

Resistance must be set to 1%, 1210, 1/4W.

Connect ground signal to the earth at only one point, near the power supply.

The network power supply need not be at the end of the network

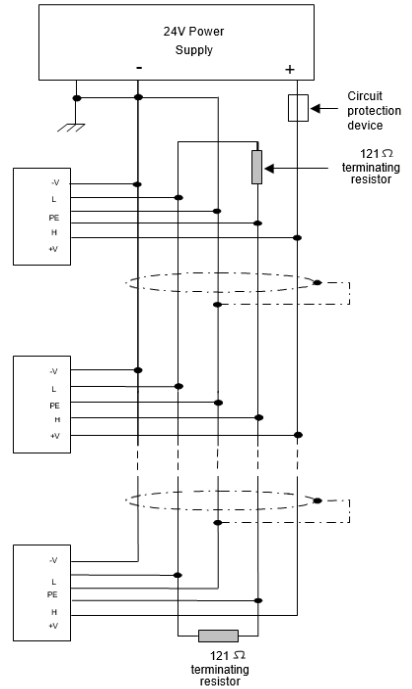

### CANbus Connector

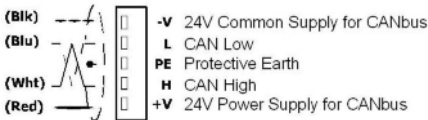

The information in this document reflects products at the date of printing. Unitronics reserves the right, subject to all applicable laws, at any time, at its sole discretion, and without notice, to discontinue or change the features, designs, materials and other specifications of its products, and to either permanently or temporarily withdraw any of the foregoing from the market.

All information in this document is provided "as is" without warranty of any kind, either expressed or implied, including but not limited to any implied warranties of merchantability, fitness for a particular purpose, or non-infringement. Unitronics assumes no responsibility for errors or omissions in the information presented in this document. In no event shall Unitronics be liable for any special, incidental, indirect or consequential damages of any kind, or any damages whatsoever arising out of or in connection with the use or performance of this information.

The tradenames, trademarks, logos and service marks presented in this document, including their design, are the property of Unitronics (1989) (R'G) Ltd. or other third parties and you are not permitted to use them without the prior written consent of Unitronics or such third party as may own them