

General Description







The products listed above are micro-PLC+HMIs, rugged programmable logic controllers that comprise built-in operating panels.

Detailed Installation Guides containing the I/O wiring diagrams for these models, technical specifications, and additional documentation are located in the Technical Library in the Unitronics website:

<https://unitronicsplc.com/support-technical-library/>

Alert Symbols and General Restrictions

When any of the following symbols appear, read the associated information carefully.

Symbol	Meaning	Description
	Danger	The identified danger causes physical and property damage.
	Warning	The identified danger could cause physical and property damage.
<i>Caution</i>	Caution	Use caution.
<ul style="list-style-type: none">▪ Before using this product, the user must read and understand this document.▪ All examples and diagrams are intended to aid understanding, and do not guarantee operation. Unitronics accepts no responsibility for actual use of this product based on these examples.▪ Please dispose of this product according to local and national standards and regulations.▪ Only qualified service personnel should open this device or carry out repairs.		
		<ul style="list-style-type: none">▪ Failure to comply with appropriate safety guidelines can cause severe injury or property damage.
		<ul style="list-style-type: none">▪ Do not attempt to use this device with parameters that exceed permissible levels.▪ To avoid damaging the system, do not connect/disconnect the device when power is on.
<h3>Environmental Considerations</h3>		
		<ul style="list-style-type: none">▪ Do not install in areas with: excessive or conductive dust, corrosive or flammable gas, moisture or rain, excessive heat, regular impact shocks or excessive vibration, in accordance with the standards given in the product's technical specification sheet.▪ Do not place in water or let water leak onto the unit.▪ Do not allow debris to fall inside the unit during installation.
		<ul style="list-style-type: none">▪ Ventilation: 10mm space required between controller's top/bottom edges & enclosure walls.▪ Install at maximum distance from high-voltage cables and power equipment.

Mounting

Note that figures are for illustrative purposes only.

Dimensions

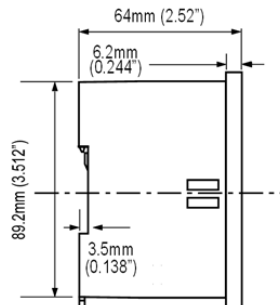
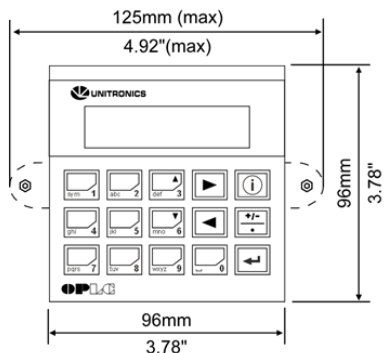

Model	Cut-out	View area
V120	92x92 mm (3.622"x3.622")	57.5x30.5mm (2.26"x1.2")
M91	92x92 mm (3.622"x3.622")	62x15.7mm (2.44"x0.61")

Panel Mounting

Before you begin, note that the mounting panel cannot be more than 5 mm thick.

1. Make a panel cut-out of the appropriate size:
2. Slide the controller into the cut-out, ensuring that the rubber seal is in place.
3. Push the mounting brackets into their slots on the sides of the panel as shown in the figure below.
4. Tighten the bracket's screws against the panel. Hold the bracket securely against the unit while tightening the screw.
5. When properly mounted, the controller is squarely situated in the panel cut-out as shown in the accompanying figures.

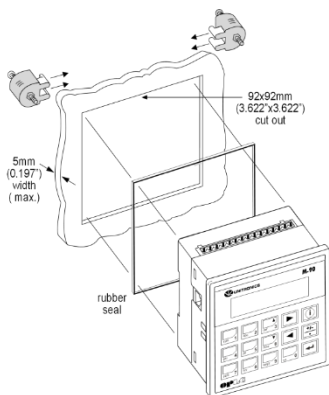

DIN-rail Mounting

1. Snap the controller onto the DIN rail as shown in the figure to the right.

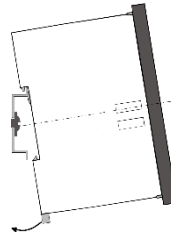

2. When properly mounted, the controller is squarely situated on the DIN-rail as shown in the figure to the right.

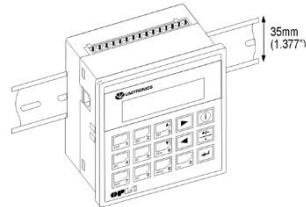

Wiring



- Do not touch live wires.

- This equipment is designed to operate only in SELV/PELV/Class 2/Limited Power environments.
- All power supplies in the system must include double insulation. Power supply outputs must be rated as SELV/PELV/Class 2/Limited Power.
- Do not connect either the 'Neutral' or 'Line' signal of the 110/220VAC to device's 0V pin.
- All wiring activities should be performed while power is OFF.
- Use over-current protection, such as a fuse or circuit breaker, to avoid excessive currents into the power supply connection point.
- Unused points should not be connected (unless otherwise specified). Ignoring this directive may damage the device.
- Double-check all wiring before turning on the power supply.



- To avoid damaging the wire, do not exceed a maximum torque of:
 - Controllers offering a terminal block with pitch of 5mm: 0.5 N·m (5 kgf·cm).
 - Controllers offering a terminal block with pitch of 3.81mm f 0.2 N·m (2 kgf·cm).
- Do not use tin, solder, or any substance on stripped wire that might cause the wire strand to break.
- Install at maximum distance from high-voltage cables and power equipment.

Caution

Wiring Procedure

Use crimp terminals for wiring;

- Controllers offering a terminal block with pitch of 5mm: 26-12 AWG wire (0.13 mm² –3.31 mm²).
- Controllers offering a terminal block with pitch of 3.81mm: 26-16 AWG wire (0.13 mm² – 1.31 mm²).

1. Strip the wire to a length of $7\pm 0.5\text{mm}$ (0.270–0.300").
2. Unscrew the terminal to its widest position before inserting a wire.
3. Insert the wire completely into the terminal to ensure a proper connection.
4. Tighten enough to keep the wire from pulling free.

Wiring Guidelines

- Use separate wiring ducts for each of the following groups:
 - Group 1: Low voltage I/O and supply lines, communication lines.
 - Group 2: High voltage Lines, Low voltage noisy lines like motor driver outputs.
 Separate these groups by at least 10cm (4"). If this is not possible, cross the ducts at a 90° angle.
 - For proper system operation, all 0V points in the system should be connected to the system 0V supply rail.
 - Product-specific documentation must be fully read and understood before performing any wiring.
- Allow for voltage drop and noise interference with input lines used over an extended distance.
Use wire that is properly sized for the load.

Earthing the product

To maximize system performance, avoid electromagnetic interference as follows:

- Use a metal cabinet.
- Connect the 0V and functional ground points (if exist) directly to the earth ground of the system.
- Use the shortest, less than 1m (3.3 ft.) and thickest, 2.08mm^2 (14AWG) min, wires possible.

UL Compliance

The following section is relevant to Unitronics' products that are listed with the UL.

The following models: V120-22-T1, V120-22-T2C, V120-22-UA2, V120-22-UN2, M91-2-R1, M91-2-R2C, M91-2-R6, M91-2-R6C, M91-2-T1, M91-2-T2C, M91-2-UA2, M91-2-UN2 are UL listed for Hazardous Locations.

The following models: V120-22-R1, V120-22-R2C, V120-22-R34, V120-22-R6, V120-22-R6C, V120-22-RA22, V120-22-T1, V120-22-T2C, V120-22-T38, V120-22-UA2, V120-22-UN2, M91-2-FL1, M91-2-PZ1, M91-2-R1, M91-2-R2, M91-2-R2C, M91-2-R34, M91-2-R6, M91-2-R6C, M91-2-RA22, M91-2-T1, M91-2-T2C, M91-2-T38, M91-2-TC2, M91-2-UA2, M91-2-UN2, M91-2-ZK, M91-T4-FL1, M91-T4-PZ1, M91-T4-R1, M91-T4-R2, M91-T4-R2C, M91-T4-R34, M91-T4-R6, M91-T4-R6C, M91-T4-RA22, M91-T4-T1, M91-T4-T2C, M91-T4-T38, M91-T4-TC2, M91-T4-UA2, M91-T4-UN2, M91-T4-ZK are UL listed for Ordinary Location.

For models from series M91, that include "T4" in the Model name, Suitable for mounting on the flat surface of Type 4X enclosure.

For examples: M91-T4-R6

UL Ordinary Location

In order to meet the UL ordinary location standard, panel-mount this device on the flat surface of Type 1 or 4 X enclosures

UL Ratings, Programmable Controllers for Use in Hazardous Locations,

Class I, Division 2, Groups A, B, C and D

These Release Notes relate to all Untronics products that bear the UL symbols used to mark products that have been approved for use in hazardous locations, Class I, Division 2, Groups A, B, C and D.

Caution ▪ This equipment is suitable for use in Class I, Division 2, Groups A, B, C and D, or Non-hazardous locations only.



▪ Input and output wiring must be in accordance with Class I, Division 2 wiring methods and in accordance with the authority having jurisdiction.



▪ WARNING—Explosion Hazard—substitution of components may impair suitability for Class I, Division 2.

▪ WARNING – EXPLOSION HAZARD – Do not connect or disconnect equipment unless power has been switched off or the area is known to be non-hazardous.

▪ WARNING – Exposure to some chemicals may degrade the sealing properties of material used in Relays.

▪ This equipment must be installed using wiring methods as required for Class I, Division 2 as per the NEC and/or CEC.

Panel-Mounting

For programmable controllers that can be mounted also on panel, in order to meet the UL Haz Loc standard, panel-mount this device on the flat surface of Type 1 or Type 4X enclosures.

Relay Output Resistance Ratings

The products listed below contain relay outputs:

Programmable controllers, Models: M91-2-R1, M91-2-R2C, M91-2-R6C, M91-2-R6

- When these specific products are used in hazardous locations, they are rated at 3A res.
 - when these specific products are used in non-hazardous environmental conditions, they are rated at 5A res, as given in the product's specifications.
-

Temperature Ranges

Programmable Logic Controllers, Models, M91-2-R1, M91-2-R2C, M91-2-R6C.

- When these specific products are used in hazardous locations, they may be used only within a temperature range of 0-40°C (32- 104°F).
 - When these specific products are used in non-hazardous environmental conditions, they function within the range of 0-50°C (32- 122°F) given in the product's specifications.
-

Removing / Replacing the battery

When a product has been installed with a battery, do not remove or replace the battery unless the power has been switched off, or the area is known to be non-hazardous.

Please note that it is recommended to back up all data retained in RAM, in order to avoid losing data when changing the battery while the power is switched off. Date and time information will also need to be reset after the procedure.

UL des zones ordinaires:

Pour respecter la norme UL des zones ordinaires, monter l'appareil sur une surface plane de type de protection 1 ou 4X

Certification UL des automates programmables, pour une utilisation en environnement à risques, Class I, Division 2, Groups A, B, C et D.

Cette note fait référence à tous les produits Unitronics portant le symbole UL - produits qui ont été certifiés pour une utilisation dans des endroits dangereux, Classe I, Division 2, Groupes A, B, C et D.

Attention ■ Cet équipement est adapté pour une utilisation en Classe I, Division 2, Groupes A, B, C et D, ou dans Non-dangereux endroits seulement.



■ Le câblage des entrées/sorties doit être en accord avec les méthodes de câblage selon la Classe I, Division 2 et en accord avec l'autorité compétente.



■ AVERTISSEMENT: Risque d'Explosion – Le remplacement de certains composants rend caduque la certification du produit selon la Classe I, Division 2.

■ AVERTISSEMENT - DANGER D'EXPLOSION - Ne connecter pas ou ne débranche pas l'équipement sans avoir préalablement coupé l'alimentation électrique ou la zone est reconnue pour être non dangereuse.

■ AVERTISSEMENT - L'exposition à certains produits chimiques peut dégrader les propriétés des matériaux utilisés pour l'étanchéité dans les relais.

■ Cet équipement doit être installé utilisant des méthodes de câblage suivant la norme Class I, Division 2 NEC et /ou CEC.

Montage de l'écran:

Pour les automates programmables qui peuvent aussi être monté sur l'écran, pour pouvoir être au standard UL, l'écran doit être monté dans un coffret avec une surface plane de type 1 ou de type 4X.

Certification de la résistance des sorties relais

Les produits énumérés ci-dessous contiennent des sorties relais:

- Automates programmables, modèles : M91-2-R1, M91-2-R6C, M91-2-R6, M91-2-R2C
- Lorsque ces produits spécifiques sont utilisés dans des endroits dangereux, ils supportent un courant de 3A charge résistive.
- Lorsque ces produits spécifiques sont utilisés dans un environnement non dangereux, ils sont évalués à 5A res, comme indiqué dans les spécifications du produit Plages de températures.

Plages de température

Les Automates programmables, modèles: M91-2-R1, M91-2-R2C, M91-2-R6C.

- Dans un environnement dangereux, ils peuvent être seulement utilisés dans une plage de température allant de 0 et 40° C (32- 104°F).
- Dans un environnement non dangereux, ils peuvent être utilisés dans une plage de température allant de 0 et 50° C (32- 122°F).

Retrait / Remplacement de la batterie

Lorsqu'un produit a été installé avec une batterie, retirez et remplacez la batterie seulement si l'alimentation est éteinte ou si l'environnement n'est pas dangereux.

Veuillez noter qu'il est recommandé de sauvegarder toutes les données conservées dans la RAM, afin d'éviter de perdre des données lors du changement de la batterie lorsque l'alimentation est coupée. Les informations sur la date et l'heure devront également être réinitialisées après la procédure.

V120-22-UA2

Graphic Operator Panel & Programmable Logic Controller

24VDC, 12 pnp/npn digital inputs, 2 universal inputs*, high-speed counter/shaft encoder input, 10 transistor outputs, 2 analog outputs, I/O expansion port, 2 RS232/RS485 ports

Power supply	24VDC
Permissible range	20.4VDC to 28.8VDC with less than 10% ripple
Maximum current consumption	210mA@24VDC (pnp inputs) 315mA@24VDC (npn inputs)
Digital inputs	12 pnp (source) or npn (sink) inputs. See Note 1.
Nominal input voltage	24VDC. See Note 2.
Input voltages for pnp (source)	0-5VDC for Logic '0' 17-28.8VDC for Logic '1'
Input voltages for npn (sink)	17-28.8VDC/<2mA for Logic '0' 0-5VDC/>6mA for Logic '1'
Input current	8mA@24VDC
Input impedance	3K Ω
Response time (except high-speed inputs)	10mS typical
Galvanic isolation	None
Input cable length	Up to 100 meters, unshielded
High-speed counter	Specifications below apply when inputs are wired for use as a high-speed counter input/shaft encoder. See Note 3 and 4.
Resolution	32-bit
Input frequency	10kHz max.
Minimum pulse	40 μ s

Notes:

- All 12 inputs can be set to pnp (source) or npn (sink) via a single jumper and appropriate wiring.
- npn (sink) inputs use voltage supplied from the controller's power supply.
- Input #0 can function as either high-speed counter or as part of a shaft encoder. In each case, high-speed input specifications apply. When used as a normal digital input, normal input specifications apply.
- Input #1 can function as either counter reset, or as a normal digital input; in either case, specifications are those of a normal digital input. This input may also be used as part of a shaft encoder. In this case, high-speed input specifications apply.

* Certain inputs can function as normal digital inputs, analog inputs or thermocouple inputs, in accordance with jumper settings and wiring connections.



Warnings:

- Unused pins should not be connected. Ignoring this directive may damage the controller.
- Improper use of this product may severely damage the controller.
- Refer to the controller's User Guide regarding wiring considerations.
- Before using this product, it is the responsibility of the user to read the product's User Guide and all accompanying documentation.

Power supply, pnp (source) inputs

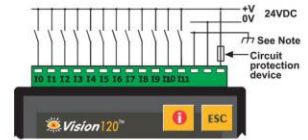

Note:

To avoid electromagnetic interference, mount the controller in a metal panel/cabinet and earth the power supply. Earth the power supply signal to the metal using a wire whose length does not exceed 10cm. If your conditions do not permit this, do not earth the power supply.

npn (sink) inputs

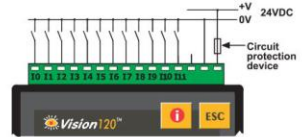

pnp (source) high-speed counter

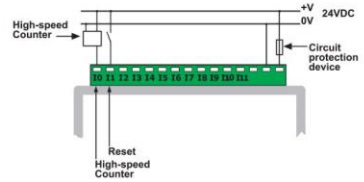

npn (sink) high-speed counter

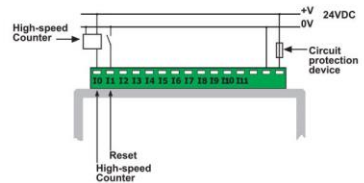

Shaft encoder

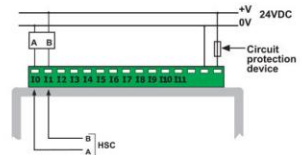

Universal Inputs

Analog Inputs	
	Two 14-bit, multi-range inputs: 0-10V, 0-20mA, 4-20mA See Note 1
Conversion method	Voltage to Frequency
Input impedance	>400K Ω for voltage 500 Ω for current
Isolation	None
Resolution (except 4-20mA)	14-bit (16384 units)
Resolution at 4-20mA	3277 to 16383 (13107 units)
Conversion time	100mSec minimum (according to filter type)
Absolute max. rating	$\pm 15V$ for voltage $\pm 30mA$ for current
Linearity error	0.04% max. of full scale
Error limit	0.4% of input value
Status indication	Yes, see Note 2

Notes:

- Inputs #8 and #10 can each function as an analog input, related to signal 0V, in accordance with jumper settings and wiring connections.
- The analog value can also indicate faults, as shown below:

Value	Possible Cause
-1	Input value deviates slightly below the input range.
16384	Input value deviates slightly above the input range.
32767	Input value deviates greatly above or below the input range.

Voltage / Current connection

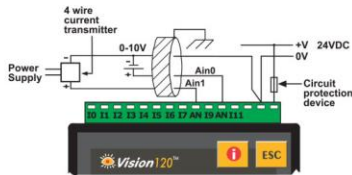

Notes:

- Shields should be connected at the signals' source.
- The 0V signal of the analog input must be connected to the controller's 0V.

Current connection

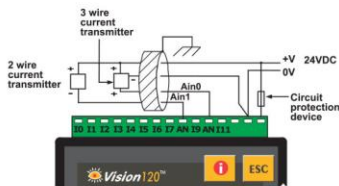

Notes:

- Shields should be connected at the signals' source.
- The 0V signal of the analog input must be connected to the controller's 0V.

Thermocouple inputs	
	2 differential inputs. See Note 1.
Input type	Thermocouple
Input ranges	As shown in the table below
Isolation	None
Conversion method	Voltage to Frequency
Resolution	0.1°C / 0.1°F
Conversion time	100mSec minimum (according to filter type)
Input impedance	>10M Ω
Cold junction compensation	local, automatic
Cold junction compensation error	$\pm 1.5^\circ C$ / $\pm 2.7^\circ F$ maximum
Absolute maximum rating	± 0.6 VDC
Linearity error	0.04% max. of full scale
Error limit	0.4% of input value
Status indication	None
Warm-up time	$\frac{1}{2}$ hour typically, $\pm 1^\circ C$ / $\pm 1.8^\circ F$ repeatability

Notes:

- Thermocouple #0: use Input #10 as positive input & Input #9 as negative input.
Thermocouple #1: use Input #8 as positive input & Input #7 as negative input.
To use inputs as thermocouple, set the relevant jumpers and use appropriate wiring.

Table 1: Input Ranges

Type	Temperature range	Wire color	
		ANSI (USA)	BS 1843 (UK)
mV	-5 to 56mV	-	-
B	200 to 1820°C (300 to 3276°F)	+ Grey - Red	+ None - Blue
E	-200 to 750°C (-328 to 1382°F)	+ Violet - Red	+ Brown - Blue
J	-200 to 760°C (-328 to 1400°F)	+ White - Red	+ Yellow - Blue
K	-200 to 1250°C (-328 to 2282°F)	+ Yellow - Red	+ Brown - Blue
N	-200 to 1300°C (-328 to 2372°F)	+ Orange - Red	+ Orange - Blue
R	0 to 1768°C (32 to 3214°F)	+ Black - Red	+ White - Blue
S	0 to 1768°C (32 to 3214°F)	+ Black - Red	+ White - Blue
T	-200 to 400°C (-328 to 752°F)	+ Blue - Red	+ White - Blue

Thermocouple connection

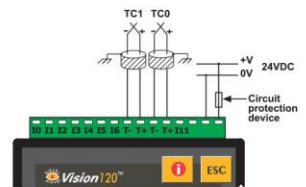

Note:

Shields should be connected at the signals' source.

Digital outputs	10 pnp (source) outputs 24VDC
Output type	P-MOSFET (open drain)
Isolation	None
Output current	0.5A max. Total current: 3A max.
Max. frequency for normal outputs	50Hz (resistive load) 0.5Hz (inductive load)
High speed output maximum frequency	2kHz (resistive load) See Note 1.
Short circuit protection	Yes
Short indication	by software
On voltage drop	0.5VDC maximum
Power supply for outputs	
Operating voltage	20.4 to 28.8VDC
Nominal operating voltage	24VDC

Note:

- Output #0 and Output #1 may be used as high-speed outputs.

Digital Outputs connection

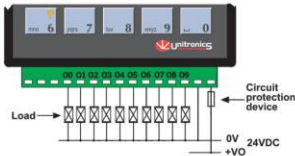

Analog outputs	Two 12-bit analog outputs: 0-10V, 4-20mA, See note 1.
Load impedance	1k Ω minimum—voltage 500 Ω maximum—current
Galvanic isolation	None
Resolution	12-bit (4096 units)
Conversion time	Synchronized to scan time
Linearity error	$\pm 0.1\%$
Operational error limits	$\pm 0.2\%$

Note:

- Each analog output range is defined by wiring, jumpers and within the controller's software.

Analog outputs connection

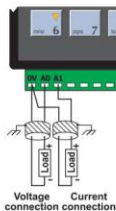

Notes:

- Shields should be earthed, connected to the earth of the cabinet.
- The 0V signal of the analog outputs must be the same 0V used by the controller's power supply.

Graphic Display	STN, LCD display
Illumination backlight	LED, yellow-green, software-controlled
Display resolution	128x64 pixels

Keypad	Sealed membrane
Number of keys	16

Program	
Application memory	448K
Memory Bits (coils)	2048
Memory Integers (registers)	1600
Long Integers (32 bit)	256
Double Word (32 bit unsigned)	64
Floats	24
Timers	192
Counters	24
Data Tables	120K (RAM) / 64K (FLASH)
HMI displays	Up to 255
Execution time	0.8 μ s for bit operations

RS232/RS485 serial ports	Used for: <ul style="list-style-type: none"> Application Download/Upload Application Testing (Debug) Connect to GSM or standard telephone modem: <ul style="list-style-type: none"> Send/receive SMS messages Remote access programming RS485 Networking
---------------------------------	---

RS232 (see note)	2 ports
Galvanic isolation	None
Voltage limits	$\pm 20V$

RS485 (see note)	2 ports
Input voltage	-7 to +12V differential max.
Cable type	Shielded twisted pair, in compliance with EIA RS485
Galvanic isolation	None
Baud rate	110 – 57600 bps
Nodes	Up to 32

Note:

RS232/RS485 is determined by jumper settings and wiring. Refer to the controller's User Guide regarding communications.

I/O expansion port	Up to 128 additional I/Os, including digital & analog I/Os, RTD and more.
---------------------------	---

Miscellaneous	
Clock (RTC)	Real-time clock functions (Date and time).
Battery back-up	7 years typical battery back-up for RTC and system data.
Battery	Coin type, 3V lithium battery, CR2450
Weight	280g. (9.8oz)
Operational temperature	0 to 50°C (32 to 122°F)
Storage temperature	-20 to 60°C (-4 to 140°F)
Relative Humidity (RH)	5% to 95% (non-condensing)
Mounting method	DIN-rail mounted (IP20/NEMA1) Panel mounted (IP65/NEMA4X)

M91-2-UA2

24 VDC, 12 pnp/npn digital inputs, *2 universal inputs, high-speed counter/shaft encoder input, 10 transistor outputs, 2 analog outputs, I/O expansion port, RS232/RS485 port

Power supply	24VDC
Permissible range	20.4VDC to 28.8VDC with less than 10% ripple
Maximum current consumption	145mA@24VDC (pnp inputs) 250mA@24VDC (nnp inputs)
Digital inputs	12 pnp (source) or npn (sink) inputs. See Note 1.
Nominal input voltage	24VDC. See Note 2
Input voltages for pnp (source)	0-5VDC for Logic '0' 17-28.8VDC for Logic '1'
Input voltages for npn (sink)	17-28.8VDC/<2mA for Logic '0' 0-5VDC/>6mA for Logic '1'
Input current	8mA@24VDC
Input impedance	3KΩ
Response time (except high-speed inputs)	10mS typical
Galvanic isolation	None
Input cable length	Up to 100 meters, unshielded
High-speed counter	Specifications below apply when inputs are wired for use as a high-speed counter input/shaft encoder. See Notes 3 and 4.
Resolution	16-bit
Input freq.	10kHz max.
Minimum pulse	40μs

Notes:

- All 12 inputs can be set to pnp (source) or npn (sink) via a single jumper and appropriate wiring.
- nnp (sink) inputs use voltage supplied from the controller's power supply.
- Input #0 can function as either high-speed counter or as part of a shaft encoder. In each case, high-speed input specifications apply. When used as a normal digital input, normal input specifications apply.
- Input #1 can function as either counter reset, or as a normal digital input; in either case, specifications are those of a normal digital input.

This input may also be used as part of a shaft encoder. In this case, high-speed input specifications apply.

* Certain inputs can function as normal digital inputs, analog inputs or thermocouple inputs, in accordance with jumper settings and wiring connections.

Warnings:

- Unused pins should not be connected. Ignoring this directive may damage the controller.
- Improper use of this product may severely damage the controller.
- Refer to the controller's User Guide regarding wiring considerations.
- Before using this product, it is the responsibility of the user to read the product's User Guide and all accompanying documentation.

Power supply, pnp (source) inputs

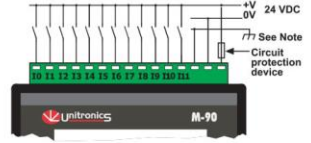

Note:
To avoid electromagnetic interference, mount the controller in a metal panel/cabinet and earth the power supply. Earth the power supply signal to the metal using a wire whose length does not exceed 10cm. If your conditions do not permit this, do not earth the power supply.

nnp (sink) inputs

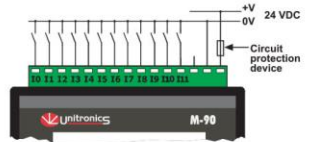

pnp (source) high-speed counter

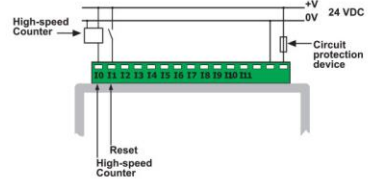

nnp (sink) high-speed counter

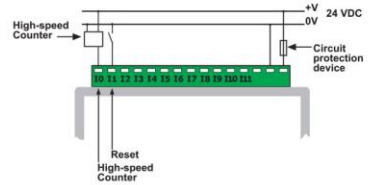

Shaft encoder

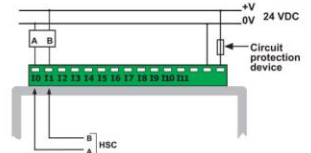

Universal Inputs

Analog Inputs	
Conversion method	Two 14-bit, multi-range inputs: 0-10V, 0-20mA, 4-20mA See Note 1
Input impedance	>400K Ω for voltage 500 Ω for current
Isolation	None
Resolution (except 4-20mA)	14-bit (16384 units)
Resolution at 4-20mA	3277 to 16383 (13557 units)
Conversion time	100mSec minimum (according to filter type)
Absolute max. rating	$\pm 15V$ for voltage $\pm 30mA$ for current
Linearity error	0.04% max. of full scale
Error limit	0.4% of input value
Status indication	Yes, see Note 2

Notes:

1. Input#8 and input#10 can be used as analog inputs, related to signal 0V, in accordance with jumper settings and wiring connections.
2. The analog value can also indicate faults, as shown below:

Value	Possible Cause
-1	Input value deviates slightly below the input range.
16384	Input value deviates slightly above the input range
32767	Input value deviates greatly above or below the input range.

Voltage / Current connection

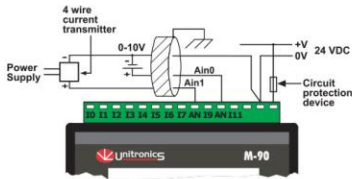

Notes:

- a. Shields should be connected at the signals' source.
- b. The 0V signal of the analog input must be connected to the controller's 0V.

Current connection

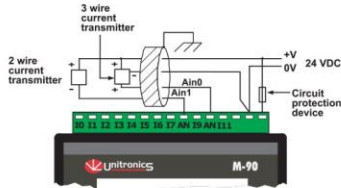

Notes:

- a. Shields should be connected at the signals' source.
- b. The 0V signal of the analog input must be connected to the controller's 0V.

Thermocouple inputs	
Input type	Thermocouple
Input ranges	As shown in the table below
Isolation	None
Conversion method	Voltage to Frequency
Resolution	0.1°C / 0.1°F
Conversion time	100mSec minimum (according to filter type)
Input impedance	>10M Ω
Cold junction compensation	local, automatic
Cold junction compensation error	$\pm 1.5^\circ C / \pm 2.7^\circ F$ maximum
Absolute maximum rating	± 0.6 VDC
Linearity error	0.04% max. of full scale
Error limit	0.4% of input value
Status indication	None
Warm-up time	$\frac{1}{2}$ hour typically, $\pm 1^\circ C / \pm 1.8^\circ F$ repeatability

Notes:

1. Thermocouple #0: use Input#10 as positive input & Input #9 as negative input.
Thermocouple #1: use Input#8 as positive input & Input #7 as negative input.
To use inputs as thermocouple, set the relevant jumpers and use appropriate wiring.

Table 1: input ranges

Type	Temperature range	Wire color	
		ANSI (USA)	BS 1843 (UK)
mV	-5 to 56mV	-	-
B	200 to 1820°C (300 to 3276°F)	+ Grey - Red	+ None - Blue
E	-200 to 750°C (-328 to 1382°F)	+ Violet - Red	+ Brown - Blue
J	-200 to 760°C (-328 to 1400°F)	+ White - Red	+ Yellow - Blue
K	-200 to 1250°C (-328 to 2282°F)	+ Yellow - Red	+ Brown - Blue
N	-200 to 1300°C (-328 to 2372°F)	+ Orange - Red	+ Orange - Blue
R	0 to 1768°C (32 to 3214°F)	+ Black - Red	+ White - Blue
S	0 to 1768°C (32 to 3214°F)	+ Black - Red	+ White - Blue
T	-200 to 400°C (-328 to 752°F)	+ Blue - Red	+ White - Blue

Thermocouple connection

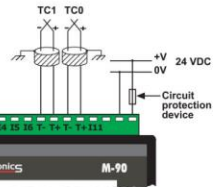

Note:

Shields should be connected at the signals' source.

Digital outputs	10 pnp (source) outputs 24VDC
Output type	P-MOSFET (open drain)
Isolation	None
Output current	0.5A max. Total current: 3A max.
Max. frequency for normal outputs	50Hz (resistive load) 0.5Hz (inductive load)
High speed output maximum frequency	2kHz (resistive load) See Note 1.
Short circuit protection	Yes
Short indication	by software
On voltage drop	0.5VDC maximum
Power supply for outputs	
Operating voltage	20.4 to 28.8VDC
Nominal operating voltage	24VDC

Note:

1. Output #0 and Output #1 may be used as high-speed outputs.

Digital outputs connection

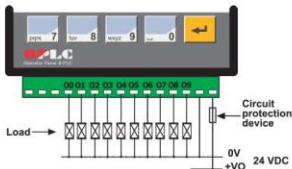

Analog outputs	Two 12-bit analog outputs: 0-10V, 4-20mA, See note 1.
Load impedance	1k Ω minimum—voltage 500 Ω maximum—current
Galvanic isolation	None
Resolution	12-bit (4096 units)
Conversion time	Synchronized to scan time
Linearity error	$\pm 0.1\%$
Operational error limits	$\pm 0.2\%$

Note :

1. Each analog output range is defined by wiring, jumpers and within the controller's software.

Analog outputs connection

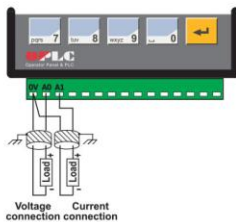

Notes:

- a. Shields should be earthed, connected to the earth of the cabinet.
- b. The 0V signal of the analog outputs must be the same 0V used by the controller's power supply.

Display	.STN, LCD display
Illumination	LED yellow-green backlight
Display size	2 lines, 16 characters long
Character size	5 x 8 matrix, 2.95 x 5.55mm
Keypad	Sealed membrane
Number of keys	15

PLC program	
Ladder Code Memory (virtual)	36K
Memory Bits (coils)	256
Memory Integers (Registers)	256
Timers	64
Execution time	12 μ sec. for bit operations
Database	1024 integers (indirect access)
HMI displays	80 user-designed displays
HMI variables	64 HMI variables are available to conditionally display and modify text, numbers, dates, times & timer values. The user can also create a list of up to 120 variable text displays, totaling up to 2K.

RS232/RS485 serial port	Used for: <ul style="list-style-type: none"> • Application Download/Upload • Application Testing (Debug) • Connect to GSM or standard telephone modem: <ul style="list-style-type: none"> - Send/receive SMS messages - Remote access programming • RS485 Networking
--------------------------------	---

RS232 (see note)	1 port
Galvanic isolation	None
Voltage limits	$\pm 20V$
RS485 (see note)	1 port
Input voltage	-7 to +12V differential max.
Cable type	Shielded twisted pair, in compliance with EIA RS485
Galvanic isolation	None
Baud rate	110 – 57600 bps
Nodes	Up to 32

Note:

RS232/RS485 is determined by jumper settings and wiring as described in the document "M91 RS485 Port Settings" packaged with the controller..

I/O expansion port	Up to 96 additional I/Os, including digital & analog I/Os, RTD and more.
---------------------------	--

Miscellaneous	
Clock (RTC)	Real-time clock functions (Date and Time).
Battery back-up	7 years typical battery back-up for RTC and system data.
Weight	270g. (9.82oz)
Operational temperature	0 to 50°C (32 to 122°F)
Storage temperature	-20 to 60°C (-4 to 140°F)
Relative Humidity (RH)	5% to 95% (non-condensing)
Mounting method	DIN-rail mounted (IP20/NEMA1) Panel mounted (IP65/NEMA4X)

Jumpers Settings

The tables below show how to set a specific jumper to change the functionality of a specific input, or analog output. To open the controller and access the jumpers, refer to the directions at the end of these specifications.

Important:

Incompatible jumper settings and wiring connections may severely damage the controller.

**JP2, JP3, JP6, JP8
Input#9 and Input#10 (universal input no. 0)**

To use as	JP2 for Input#10	JP3 for Input#9	JP6 for Input#10	JP8 for Input#10
Normal digital inputs	A	A	A	B
Thermocouple input* (See Note 1)	B	B	A	B
Analog input - voltage (see Note 3)	B	A See Note 2	B	A
Analog input - current (see Note 3)	B	A See Note 2	B	B

Notes:

1. Thermocouple input is between Input#10 (T+) and Input#9 (T-).
2. When using Input#10 as analog input, Input#9 can be used as normal digital input.
3. Analog inputs are related to signal 0V.

**JP4, JP5, JP7, JP9
Input#7 and Input#8 (universal input no. 1)**

To use as	JP4 for Input#8	JP5 for Input#7	JP7 for Input#8	JP9 for Input#8
Normal digital inputs	A	A	A	B
Thermocouple input* (See Note 1)	B	B	A	B
Analog input - voltage (see Note 3)	B	A See Note 2	B	A
Analog input - current (see Note 3)	B	A See Note 2	B	B

Notes:

1. Thermocouple input is between Input#8 (T+) and Input#7 (T-).
2. When using Input#8 as analog input, Input#7 can be used as normal digital input.
3. Analog inputs are related to signal 0V.

**JP10
Input type (for all digital inputs) -
see Note 1**

To use as	JP10
nnp (sink)	A
pnp (source)*	B

Note:

1. Inputs# 0-6, input #11 and #7-10 when these are set as normal digital inputs.

*Default factory setting

JP12
Analog output #0

To use as	JP12
Voltage*	A
Current	B

JP11
Analog output #1

To use as	JP12
Voltage*	A
Current	B

*Default factory setting

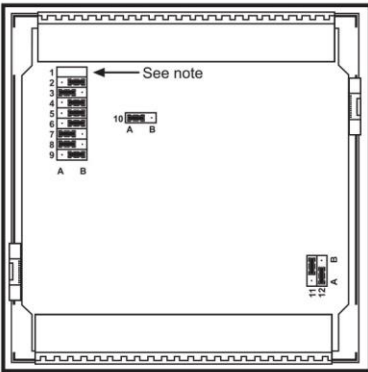

In this figure, the jumper settings will cause the inputs and the analog outputs to function as follows:

- Universal Input #0 (Input #10): Voltage input, related to 0V
- Universal Input #1 (Input #7 and Input #8): Termocouple input
- Input#9: Normal npn, 24VDC digital input
- Input#0 to Input #6 and input #11: npn, 24VDC digital inputs.

(Note that these inputs can only function as normal digital inputs.)

- Analog output #0: Voltage output
- Analog output #1: Current output

Note:
Jumper #1 is reserved - do not use.

Communication Ports

Note that different controller models offer different serial and CANbus communication options. To see which options are relevant, check your controller's technical specifications.



- Turn off power before making communications connections.

Caution

- Note that the serial ports are not isolated.
- Signals are related to the controller's 0V; the same 0V is used by the power supply.
- Always use the appropriate port adapters.

Serial Communications

This series comprises 2 serial port can be set to either RS232 or RS485 according to jumper settings. By default, the ports are set to RS232.

Use RS232 to download programs from a PC, and to communicate with serial devices and applications, such as SCADA.

Use RS485 to create a multi-drop network containing up to 32 devices.

Caution

- The serial ports are not isolated. If the controller is used with a non-isolated external device, avoid potential voltage that exceeds $\pm 10V$.

Pinouts

The pinouts below show the signals between the adapter and port.

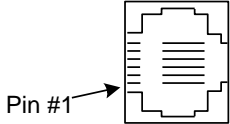
RS232		RS485		Controller Port 
Pin #	Description	Pin #	Description	
1*	DTR signal	1	A signal (+)	
2	0V reference	2	(RS232 signal)	
3	TXD signal	3	(RS232 signal)	
4	RXD signal	4	(RS232 signal)	
5	0V reference	5	(RS232 signal)	
6*	DSR signal*	6	B signal (-)	

*Standard programming cables do not provide connection points for pins 1 and 6.

RS232 to RS485: Changing Jumper Settings

- To access the jumpers, open the controller and then remove the module's PCB board. Before you begin, turn off the power supply, disconnect and dismount the controller.
- When a port is adapted to RS485, Pin 1 (DTR) is used for signal A, and Pin 6 (DSR) signal is used for signal B.
- If a port is set to RS485, **and** flow signals DTR and DSR are not used, the port can also be used to communicate via RS232; with the appropriate cables and wiring.



- Before performing these actions, touch a grounded object to discharge any electrostatic charge.
- Avoid touching the PCB board directly. Hold the PCB board by its connectors.

Opening the controller

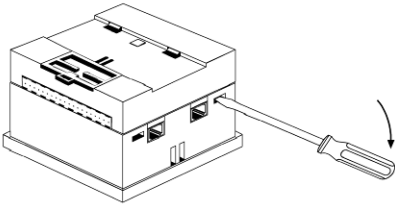

1. Turn power off before opening the controller.
2. Locate the 4 slots on the sides of the controller.
3. Using the blade of a flat-bladed screwdriver, gently pry off the back of the controller.

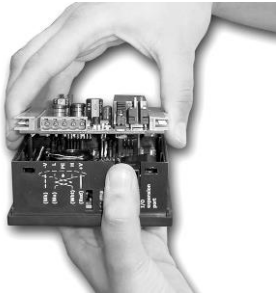

4. Gently remove the top PCB board:
 - a. Use one hand to hold the top-most PCB board by its top and bottom connectors.
 - b. With the other hand, grasp the controller, while keeping hold of the serial ports; this will keep the bottom board from being removed together with the top board.
 - c. Steadily pull the top board off.
5. Locate the jumpers, and then change the jumper settings as required.

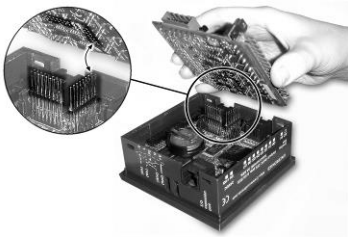

6. Gently replace the PCB board. Make certain that the pins fit correctly into their matching receptacle.
 - a. Do not force the board into place; doing so may damage the controller.
7. Close the controller by snapping the plastic cover back in its place. If the card is placed correctly, the cover will snap on easily.

M91: RS232/RS485 Jumper Settings

RS232/RS485 Jumper Setting		
To use as	Jumper 1	Jumper 2
RS232*	A	A
RS485	B	B

RS485 Termination		
Termination	Jumper 3	Jumper 4
ON*	A	A
OFF	B	B

*Default factory setting.

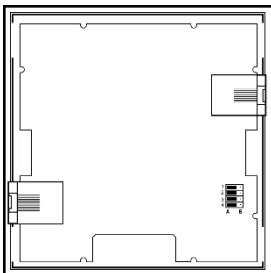

V120: RS232/RS485 Jumper Settings

	Jumper Settings		
	Jumper	RS232*	RS485
COM 1	1	A	B
	2	A	B
COM 2	5	A	B
	6	A	B

RS485 Termination		
Jumper	ON*	OFF
3	A	B
4	A	B
7	A	B
8	A	B

*Default factory setting.

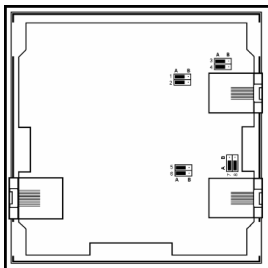

CANbus

These controllers comprise a CANbus port. Use this to create a decentralized control network of up to 63 controllers, using either Unitronics' proprietary CANbus protocol or CANopen.

The CANbus port is galvanically isolated.

CANbus Wiring

Use twisted-pair cable. DeviceNet® thick shielded twisted pair cable is recommended.

Network terminators: These are supplied with the controller. Place terminators at each end of the CANbus network.

Resistance must be set to 1%, 1210, 1/4W.

Connect ground signal to the earth at only one point, near the power supply.

The network power supply need not be at the end of the network

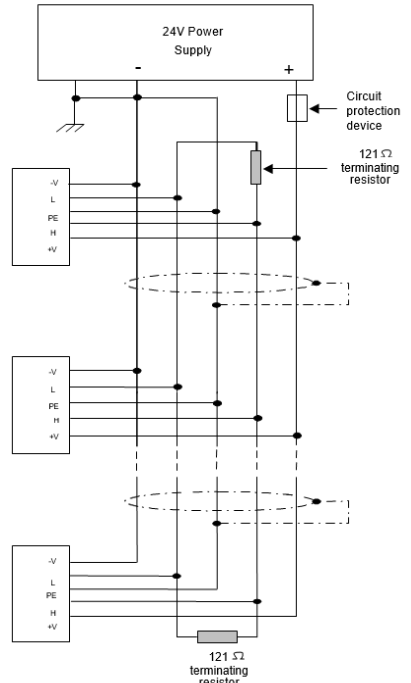

CANbus Connector

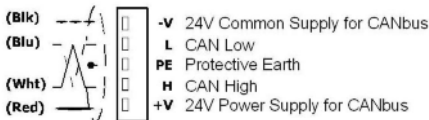

The information in this document reflects products at the date of printing. Unitronics reserves the right, subject to all applicable laws, at any time, at its sole discretion, and without notice, to discontinue or change the features, designs, materials and other specifications of its products, and to either permanently or temporarily withdraw any of the foregoing from the market.

All information in this document is provided "as is" without warranty of any kind, either expressed or implied, including but not limited to any implied warranties of merchantability, fitness for a particular purpose, or non-infringement. Unitronics assumes no responsibility for errors or omissions in the information presented in this document. In no event shall Unitronics be liable for any special, incidental, indirect or consequential damages of any kind, or any damages whatsoever arising out of or in connection with the use or performance of this information.

The tradenames, trademarks, logos and service marks presented in this document, including their design, are the property of Unitronics (1989) (R'G) Ltd. or other third parties and you are not permitted to use them without the prior written consent of Unitronics or such third party as may own them